

Min flow: 26 l/min

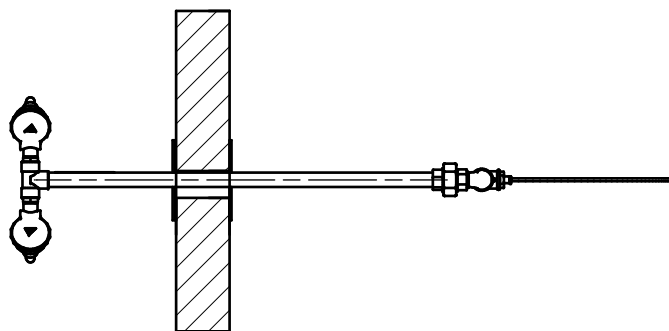
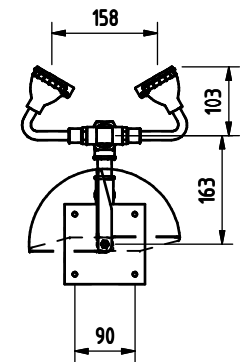

8223552